

MANIFOLD BOX SERIES GMB600



ESBE Series GMB600
Manifold for 2 or 3 units, with integrated hydraulic separator function in a box.

PRODUCT DESCRIPTION

ESBE Manifold Box Serie GMB600 is a distribution module for the management of two or three heating circuits, complemented with optional Circulation Units Serie GxA300, DN20, to suit the intended installation. Dimension of the Manifold Box allows both uninsulated as well as insulated Circulation Units to be installed.

ESBE Manifold Box consists of one box in white coloured sheet metal (E) and a pre-assembled three circuit distribution manifold (A). The Manifold Box has a separate, easy-to-hand hatch to facilitate assembly, and can be mounted on wall or recessed into the wall. A Connection box (B) that is included has two possible mounting positions, which are pre-drilled inside the box for easy installation.

When mounted inside the wall a Cover Strip (I) is available as an option to cover the transition between the box and the wall.

The manifold (A) is designed with a thermal separation between supply and return line and with integrated hydraulic separation, and the bypass function is easily controlled with an adjustment screw (F). It has two connection ports (left/right) for the supply line, and the Manifold Box is delivered with a cap (C) to use for plugging the unused connection port, to avoid unnecessary piping and speed up the installation. The manifold has a high class insulation shell according to EnEV2014 and is equipped with air vent valves which allows 360° mounting. The connections for the air vent valves can

also be used for a temperature sensor. Two plugs (D) are included if only two Circulation Units are intended to be installed and the third circuits need to be plugged.

The Manifold Box is adapted so that there is room to install shut-off valves on the primary side inside the box. Shut-off valves (H) with colour coded thermometer are available as an option.

SERVICE AND MAINTENANCE

ESBE Manifold Box does not require any specific maintenance under normal conditions.

KEY BENEFITS

- Clean appearance
- Manifold with optional function for hydraulic separation easily set with a screw
- Two incoming ports for supply where 1 is plugged to avoid unnecessary piping
- Manual air-venting which allows 90/180/270/360° mounting of the unit
- Installation of temperature sensor in connection for air vent valve possible

>>>

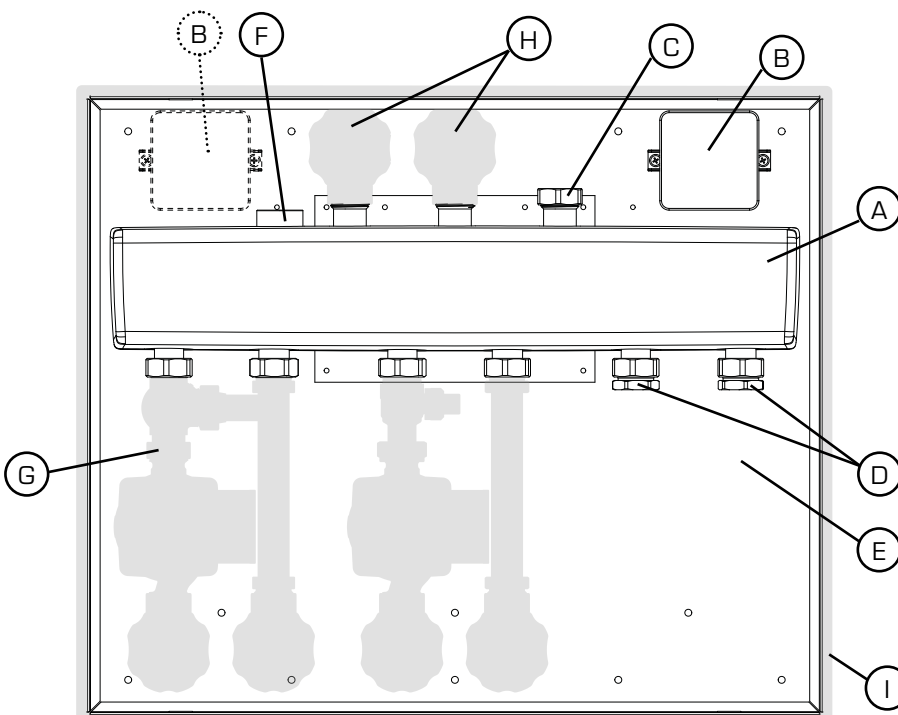

- A) Distribution manifold (1pc)
- B) Connection box (1pc)
- C) Cap (1pc)
- D) Plug (2pcs)
- E) Metal box incl. hatch (1pc)
- F) Adjustment screw (1pc)

Optional parts

- G) Circulation unit (2 or 3pcs)
- H) Shut-off valve with colour coded thermometer (2pcs)
- I) Cover strip (1pc)

MANIFOLD BOX

SERIES GMB600

OPTIONS

See separate data sheet for further detailed information about choice of Circulation unit. Each version of Circulation units can be delivered in two variants - with and without insulation shell.

Circulation units with insulation shell

Art. No.

61003200 _____ Circulation unit GDA311

61023200 _____ Circulation unit GFA311

61043600 _____ Circulation unit GRA311

Circulation units without insulation shell

Art. No.

61005200 _____ Circulation unit GDA394

61045800 _____ Circulation unit GRA394

61025100 _____ Circulation unit GFA394

Shut-off valve with colour coded thermometer

Art. No.

66100600 _____ Shut-off valve GOP810

66100700 _____ Cover strip GOP820

MANIFOLD BOX SERIES GMB600

PRODUCT ASSORTMENT

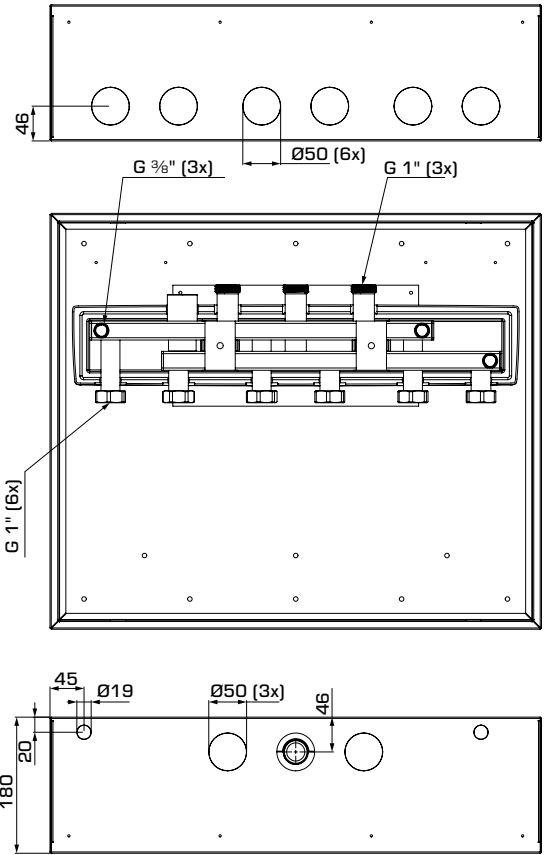
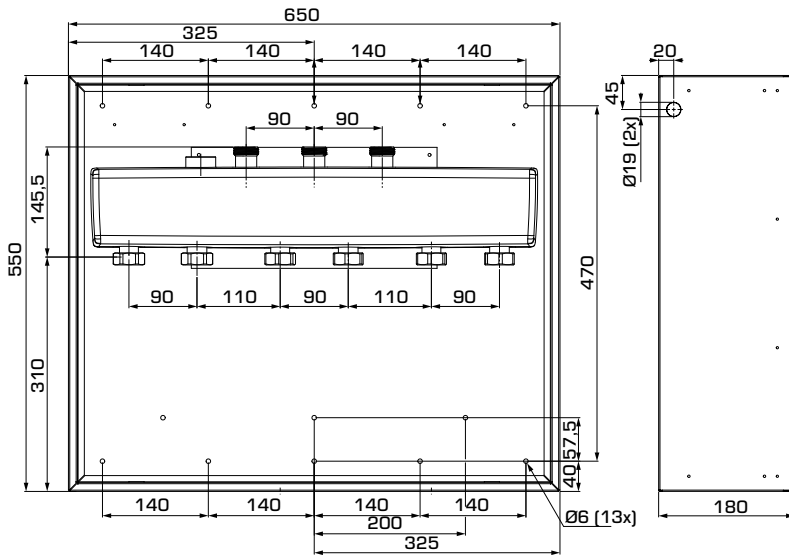

GMB631

ESBE Manifold Box Series GMB600

Art. No.	Reference	No. of circulation units	Connections			With hydraulic separator	Weight [kg]
			To system	From Heat source	Air vent valves		
66000700	GMB631	2-3	G 1"	G 1"	G 3/8"	Yes	15,5

TECHNICAL DATA



Visit esbe.eu for further detailed information.

Technical data:

Pressure class: _____ PN 6
 Media temperature: _____ max. +95°C
 _____ min. 0°C
 Working pressure: _____ 0,6 MPa (6 bar)
 Media: _____ Heating water (in accordance with VDI2035)
 _____ Water / Glycol mixtures, max. 50%.
 [above 20% admixture, the pump data must be checked]
 Standard outlet spacing: _____ 90 mm
 Flow rate at 10kPa: _____ 3,0 m³/h, see graph
 Output: _____ 70 kW at Δt 20K
 Box: _____ white coloured sheet metal, RAL 9010

Material, in contact with water:

Components of: _____ Black coated steel S235
 Insulation: _____ EPP λ 0,036 W/mK
 PED 2014/68/EU, article 4.3 / SI 2016 No. 1105 (UK)

MANIFOLD BOX SERIES GMB600

FLOW ILLUSTRATION

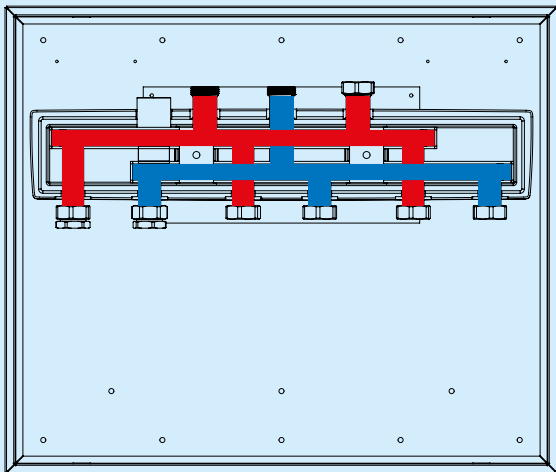

 Return



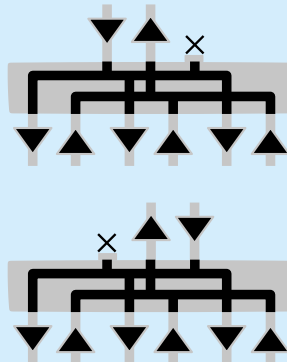





 Supply



SETTING OF HYDRAULIC SEPARATION

Kv values for bypass can be set using separate adjustment screw.

Turn the screw clockwise (inwards) to its stop position, then open it a number of turns in order to achieve a specific Kv value.

Number of turns	Kvs [m ³ /h]	By-pass set
	0	
	1	
	2	
	3	
	4	
	5	
	6	
	7	
8		

Hydraulic separation OFF

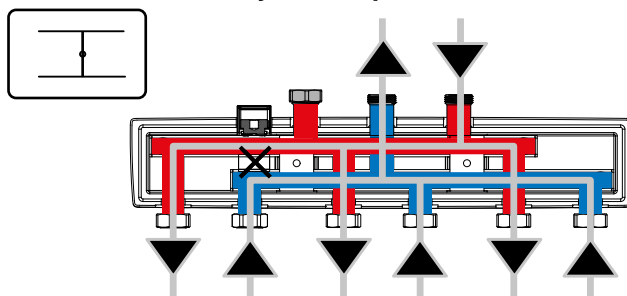

Hydraulic separation ON

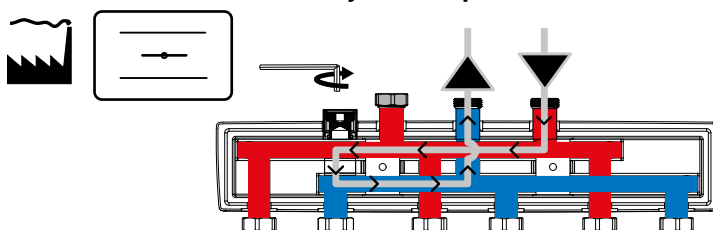

MANIFOLD BOX

SERIES GMB600

DIMENSIONING

GMB631 - Manifolds with integrated optional hydraulic separation (on/off).

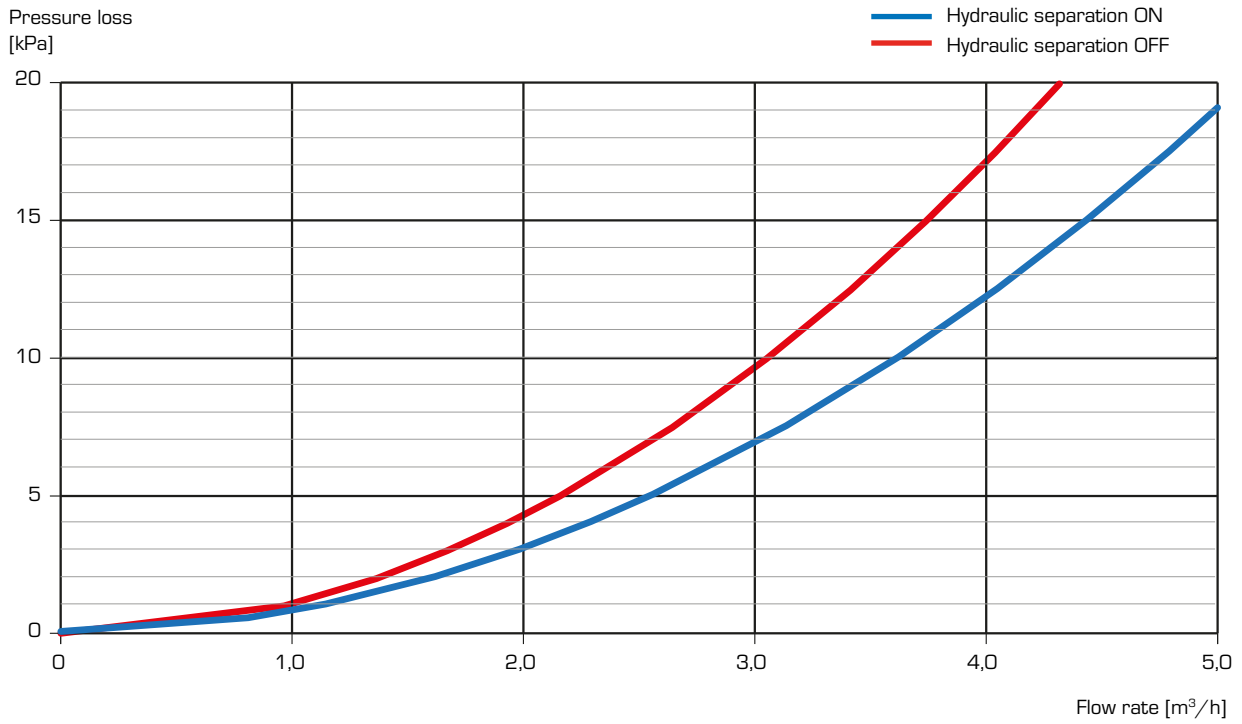

MANIFOLD BOX SERIES GMB600

INSTALLATION EXAMPLES

(A)

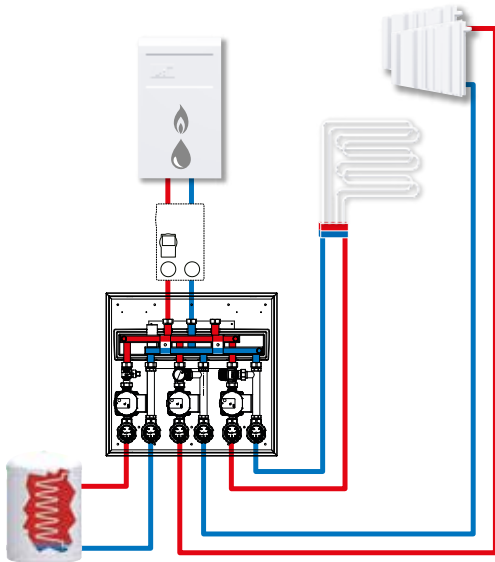

(B)

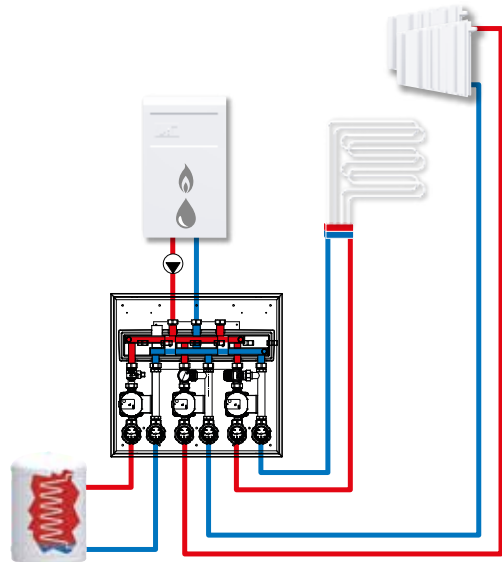

The integrated hydraulic separation in the Manifold Box Series GMB631 is switched ON if the boiler doesn't include a circulation pump but the primary side is equipped with a Circulation unit, Direct supply Series GDA, as in example A and D, or with a circulation pump, as in example B and E.

The integrated hydraulic separation in the Manifold Box Series GMB631 is switched ON if the boiler (example C and F) includes a circulation pump.

The integrated hydraulic separation is switched OFF if the boiler doesn't include a circulation pump and the primary side isn't equipped with a Circulation unit, Direct supply Series GDA, as in example A and D, or with a circulation pump, as in example B and E.

Following applications are different examples how to install ESBE Manifold Box Series GMB631 in combination with different heating sources.

(C)

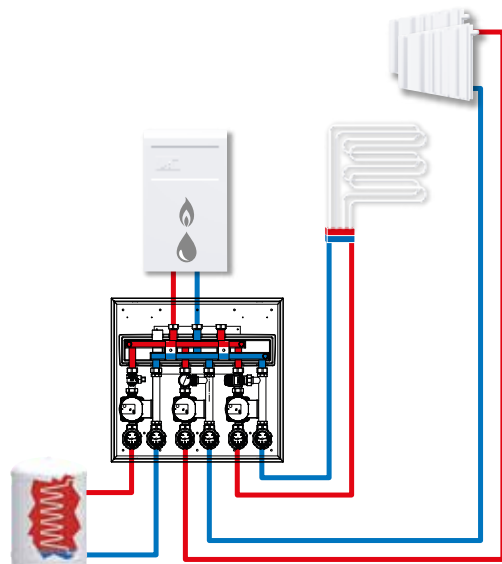

*The shown applications are only examples of product use!
Before using the product in any application, the regional and national regulations need to be checked.*

MANIFOLD BOX SERIES GMB600

INSTALLATION EXAMPLES

D

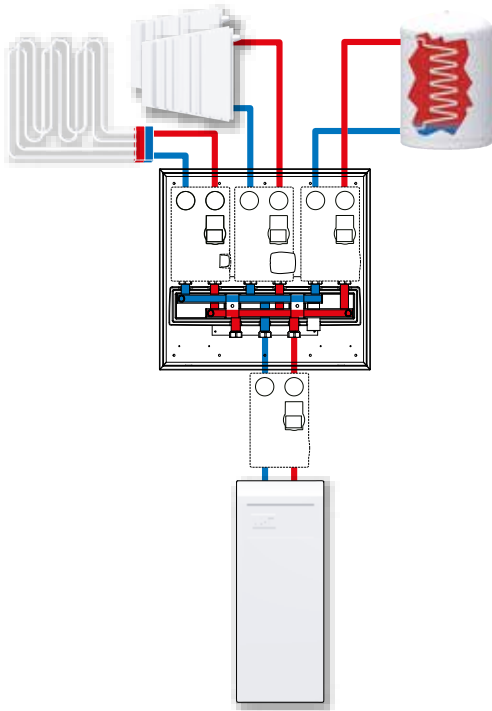

E

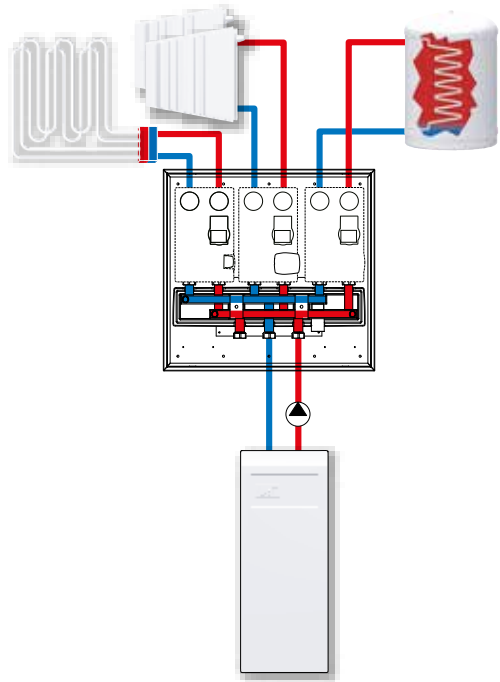

F

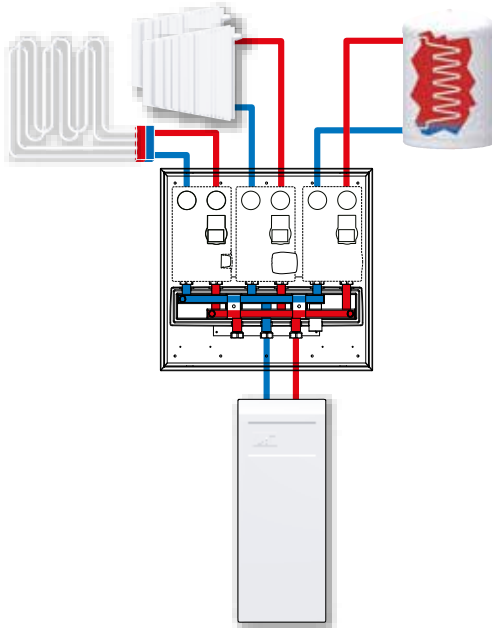

*The shown applications are only examples of product use!
Before using the product in any application, the regional and national regulations need to be checked.*